

CALLERLAB

ADVANCED DEFINITIONS



December 15, 2015

NOTE: This document is a revision of the Advanced Definitions dated October 10, 2001.
The following table shows the changes made to this document since October 10, 2001.

Date	Change
07/22/02	Added Grand Follow Your Neighbor and Triple Scoot .
01/14/04	Added Definition of "LEFT".
07/10/04	Deleted reference to "Galaxy" Formations.
07/10/04	Fixed typo in (Anything) and Cross .
12/15/04	Reformatted several diagrams.
12/27/04	Added reference to "Galaxy" Formations
12/29/04	Added Belles and Beaus to the A1 list; Updated Mini Busy .
04/13/05	Updated Grand Remake .
03/16/06	Updated Box Counter Rotate . Removed Left Pass Thru , Left Touch , and Left Square Chain Thru . Updated Left . Changed Remake , Grand Remake , 1/4 Thru , Grand 1/4 Thru , 3/4 Thru , and Grand 3/4 Thru .
09/09/06	Revised Peel and Trail and Trail Off . Incorporated various minor editorial changes.
10/04/06	Reformatted definitions.
02/06/07	Made minor corrections on pages 3 and 5.
10/09/07	Corrected Extend diagram from Left-Hand Single Quarter Tag.
11/28/07	Updated Cross Clover and (Anything) and Clover and (Anything) . Added Any Hand Concept to the Preface. Removed Cross Cloverleaf .
06/03/08	Fixed diagrams in Any Hand Concept and All 8 Concept . Added (Named Dancers) Cross .
03/01/10	Fix typo in Grand Remake .
11/17/10	Add timing to Grand Follow Your Neighbor .
12/04/10	Convert to Word with minor edits throughout. Move Any Hand Concept from Preface to A-1. Fix error in Mini-Busy . Move Box Counter Rotate , Box Transfer , and Reverse Swap Around . Added diagrams for Grand Follow Your Neighbor .
12/16/10	Change margins. Update call names to exactly match updated Advanced list: listed Clover and (Anything) and Cross Clover and (Anything) together, listed Double and Triple Star Thru together, added Quarter Top , Half the Top , and Three Quarter Top under Fractional Tops , listed Quarter Thru and Three Quarter Thru together and placed the Grand versions under that, listed Wheel Thru and Left Wheel Thru together, changed spelling of "Lock It" to "Lockit", listed Pass In and Pass Out together, listed Quarter In and Quarter Out together, added a heading Hourglass Formation and put Hourglass Circulate and Cut and Flip the Hourglass under it, listed In and Out Roll Circulate together, listed Slip , Slide , Swing , and Slither together, and listed Switch To a Diamond and Hourglass together.
02/16/11	Update copyright; fix typo in Remake ; fix diagram in Transfer and (Anything) ; add missing diagram to Zig Zag / Zag Zig .
06/13/11	Add timing for All 8 Mix .
8/16/2011	Definition revision for Transfer the Column .
10/31/2011	Definition revision for Transfer and (Anything) .
12/6/2011	Changed graphics for How We Name Dancers , Transfer the Column , Checkmate the Column , Transfer and (Anything) , and Turn and Deal .
1/11/2012	Definition revision for Swing and Mix .
4/16/2012	Changed Half Breed Thru to Brace Thru .
5/1/2012	Corrected a single issue of Half Breed Thru where it was missed on Page 1
9/13/2012	Moved Split Square Chain Thru to A1
6/1/2013	Changed description of Left Modifier and added Reverse Modifier
2/24/2014	Definition revision for Double Star Thru and Triple Star Thru
4/12/2014	Definition revision for Cast A Shadow
5/18/2015	Editorial/punctuation changes made Belles and Beaus and Brace Thru
7/6/2015	Removed reference to Hourglass Circulate from definitions of Chain Reaction and Motivate
8/15/2015	Changed timing of Ends Bend
12/15/2015	Added Triple Cross to A-1 list.

© Copyright 1982, 1986-1988, 1995, 2001-2015. Bill Davis, John Sybalsky, and CALLERLAB Inc., The International Association of Square Dance Callers. Permission to reprint, republish, and create derivative works without royalty is hereby granted, provided this notice appears. Publication on the Internet of derivative works without royalty is hereby granted provided this notice appears. Permission to quote parts or this entire document without royalty is hereby granted, provided this notice is included. Information contained herein shall not be changed nor revised in any derivation or publication.

Table of Contents

Read this First.....	1
Regional Styling Differences.....	1
General Rules.....	1
How We Name Dancers.....	2
Starting Formations.....	4
Glossary of Descriptive Terms Used in the Definitions.....	4
Formation Isn't There.....	6
How Mainstream Calls Are Extended at Advanced....	7
A-1 Definitions.....	8
Any Hand Concept.....	8
(Anything) and Cross / (Named Dancers) Cross.....	9
As Couples Concept.....	9
Belles and Beaus.....	10
Brace Thru.....	10
Cast a Shadow.....	10
Chain Reaction.....	10
Clover and (Anything) / Cross Clover and (Anything).....	11
Cross Over Circulate.....	11
Cross Trail Thru.....	11
Cycle and Wheel.....	12
Double Star Thru / Triple Star Thru.....	12
Ends Bend.....	12
Explode and (Anything).....	12
Explode the Line.....	12
Fractional Tops.....	13
Quarter Top.....	13
Half a Top.....	13
Three Quarter Top.....	13
Grand Follow Your Neighbor.....	13
Horseshoe Turn.....	13
Lockit.....	13
Mix.....	13
Pair Off.....	14
Partner Hinge.....	14
Partner Tag.....	14
Pass In/Out.....	14
Pass the Sea.....	14
Quarter In/Out.....	15
Quarter Thru / Three Quarter Thru.....	15
Grand Quarter Thru / Grand Three Quarter Thru.....	16
Grand Quarter Thru.....	16
Grand Three-Quarter Thru.....	16
Right (Left) Roll to a Wave.....	16
Scoot and Dodge.....	16
Six-Two Acey Deucey.....	16
Split Square Chain Thru.....	16
Split Square Thru.....	17
Square Chain Thru.....	17
Step and Slide.....	17
Swap Around / Reverse Swap Around.....	17
Transfer the Column.....	17
Triple Cross.....	17
Triple Scoot.....	17
Triple Trade.....	188
Turn and Deal.....	18
Wheel Thru / Left Wheel Thru.....	18
A-2 Definitions.....	19
All 4 Couples / All 8 Concepts.....	19
All 4 Couples Chase Right.....	19
All 4 Couples Right and Left Thru.....	19
All 4 Couples Star Thru, etc.....	20
All 8 Dixie Style To A Wave.....	20
All 8 Mix.....	20
All 8 Swing Thru.....	20
All 8 Walk and Dodge.....	21
Checkmate the Column.....	21
Diamond Chain Thru.....	22
Hourglass Formation:.....	22
Hourglass Circulate.....	22
Cut/Flip the Hourglass.....	22
In/Out Roll Circulate.....	23
Mini-Busy.....	24
Motivate.....	24
Pass and Roll.....	24
Pass and Roll Your Neighbor.....	24
Peel and Trail.....	24
Recycle.....	25
Remake Family.....	25
Remake.....	25
Grand Remake.....	26
Remake The Thar.....	26
Scoot and Weave.....	26
Scoot Chain Thru.....	27
Single Wheel.....	27
Slip / Slide / Swing / Slither.....	27
Spin the Windmill.....	28
Split/Box Counter Rotate.....	28
Split/Box Transfer.....	29
Swing and Mix.....	29
Switch the Wave.....	29
Switch to a Diamond/Hourglass.....	29
Trade Circulate.....	30
Trail Off.....	30
Transfer and (Anything).....	31
Zig Zag / Zag Zig.....	32

Read this First

This set of definitions is an attempt to capture the real meaning for each call on the Advanced list. It is intended to serve as the referee for disputes about exactly what a call means, and as a basis for teaching the calls properly. Whenever the *technical* definition of a call is too long or complicated to do a *first teach* from, we have provided a teaching definition or teaching hints. This way, the definitions can meet both sets of needs. Naturally, dancers should be introduced to the full definition of each call as soon as your judgment dictates.

Before you use these definitions, you should be familiar with the CALLERLAB Basic/Mainstream definitions, the CALLERLAB Plus definitions, the CALLERLAB arrangement numbers, and the CALLERLAB standard formations and names. Where possible, we have used calls and formations defined in those documents. This has let us make the definitions shorter and clearer.

Regional Styling Differences

CALLERLAB recommends that calls such as Swing Thru and Spin the Top be danced using the hands-up position and the palm star handhold. Many areas of the square dance world continue to use forearm turns for all turning actions. In order to eliminate the controversy over the use of forearm turns, the CALLERLAB membership approved a 1992 resolution recognizing that regional differences in styling exists.

General Rules

All of the general rules which apply to the Mainstream and Plus definitions also apply at Advanced.

Facing Dancers: Facing dancers, unless otherwise specified, may be any combination of men and women.

Couples: Couples, unless otherwise specified, may be any combination of men and women.

Facing Couples Rule: Some calls that normally start from an ocean wave can also be done from facing couples. In that case, the dancers first step into a momentary right-hand ocean wave and complete the call - unless the caller specifically directs a left-hand call (e.g., Left Swing Thru), in which case the dancers step into a momentary left-hand ocean wave and complete the call. This rule may also apply when calls that require parallel waves are called with the dancers in an eight chain thru formation.

The Facing Couples rule applies only to the Advanced calls Fractional Tops and Spin the Windmill.

Ocean Wave Rule: Some calls that normally start from facing couples can be done from a wave. In that case, the dancers have already stepped forward toward each other and are ready to complete the remaining action of the call. This rule also applies when calls that start from a single Eight Chain Thru formation (e.g., Pass and Roll) are called from a right-hand Box Circulate formation.

The Ocean Wave Rule applies only to these Advanced calls; the required handedness of the wave is shown for each call: Cross Trail Thru [W], Brace Thru [W], Pass and Roll [W], Pass and Roll Your Neighbor [W], Pass In [W], Pass Out [W], Pass the Sea [W], Split Square Thru [W], Split Square Chain Thru [W], Square Chain Thru [W], Left Square Chain Thru [LW].

Right-Shoulder Rule: Whenever two dancers are moving toward each other and would otherwise collide, they pass right shoulders instead. If two dancers facing opposite directions must occupy the same spot on the floor at the same time, they step to form a right-hand mini-wave instead. You may

not have two dancers who are facing the same direction, or at right angles, try to occupy the same spot.

Split versus Box: There are two versions of many calls: Split Circulate and Box Circulate; Split Transfer and Box Transfer; Split Counter Rotate and Box Counter Rotate. The Split version of a call is used when an 8-dancer formation is to be split into groups of 4 to do the call. Box is used:

- when there is only a single box circulate formation which can do the call (e.g., the center 4 of parallel two-faced lines doing a Box Transfer), --or--
- when the center 4 dancers are to do the call (e.g., from parallel waves, Centers Box Transfer while the ends Zig Zag).

It is not good practice to simply call "Box Circulate" from columns or parallel waves. Instead, use it to distinguish between Centers Box Circulate (they stay in the center) and Centers Split Circulate (they stay in their own half of the square). Either way, you must tell the centers to do the call.

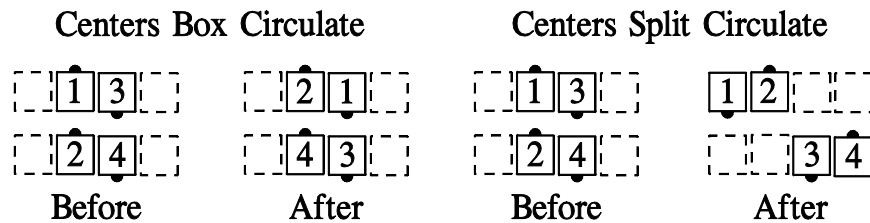

How We Name Dancers

For purposes of the definitions, we often had to identify specific dancers--say, the ends of a wave. There are a lot of ways to name people, and we tried to use the ones that are common at Advanced. For reference, we've listed them here:

#1, #2, #3, #4: The dancers in a column are sometimes identified by number. The very lead dancer is called #1; the one behind him is #2, and so on. For example, here's how the dancers below would be named:



Points and Centers: In diamonds and hourglasses, there are points and centers. The points in the diagrams below are marked "P" and the centers are marked "C":

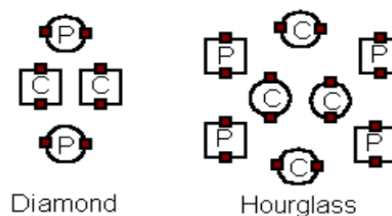

Box, Wave, and Diamond Dancers: In parallel diamonds, hourglasses, and galaxies, you can identify dancers by what part of the formation they're in. In parallel diamonds there is a wave inside a box of dancers; in an hourglass there is a diamond inside a box; in a galaxy there is a box inside a diamond. In the diagrams below, Wave Dancers are marked "W", Diamond Dancers are marked "D", and Box Dancers are marked "B":

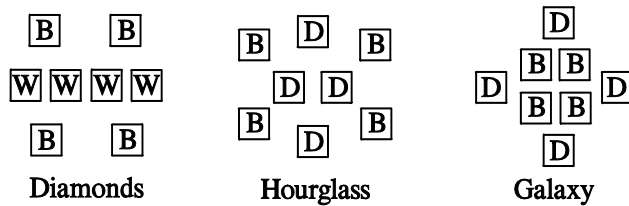

Centers and Ends: All line-type and column-type formations have ends and centers. The dancers who are nearest the center of the formation are centers, and the others are ends--regardless of their facing direction. In the diagram below, the centers are marked "C" and the ends are marked "E".



Adjacent: Two dancers are said to be *adjacent* if they are close to each other, with no intervening space or other dancers. This is true regardless of the dancers' facing directions. In the diamond and hourglass diagrams below, the dancers marked "A" are all adjacent to each other; the others aren't adjacent to anyone. In the box diagram, dancers "B" and "C" are both adjacent to dancer "A", but not to each other.

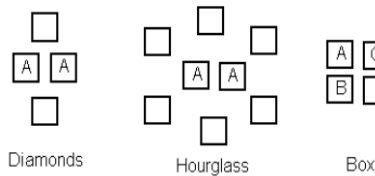

Leads (or Leaders) and Trailers: In any 1x2 formation (e.g., facing dancers, a tandem, dancers back-to-back), those facing out of the 1x2 formation are called leaders, and those facing into the 1x2 formation are called trailers. A dancer who has one shoulder directly toward the center of the 1x2 formation is neither. In the pictures below, the dancers marked "L" are leaders, and the dancers marked "T" are trailers. Those not marked are neither.

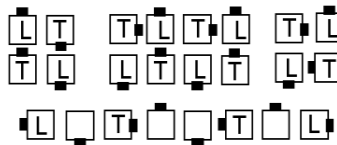

Centers and Outsides: Those dancers who are close to the center of the formation are centers; the others are outsiders. In lines and columns, end and outside are the same; in the other formations below, the centers are marked with "C" and the outsiders with "O".

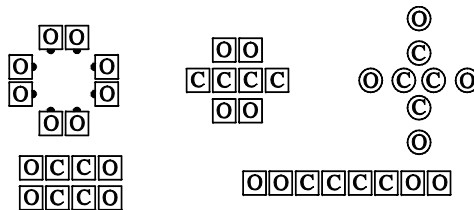

Very Centers: The two dancers closest to the flagpole center of the set are called the very centers or the very center two. This term is only used when exactly two people are closest to the center. They are marked with V's in the pictures below:

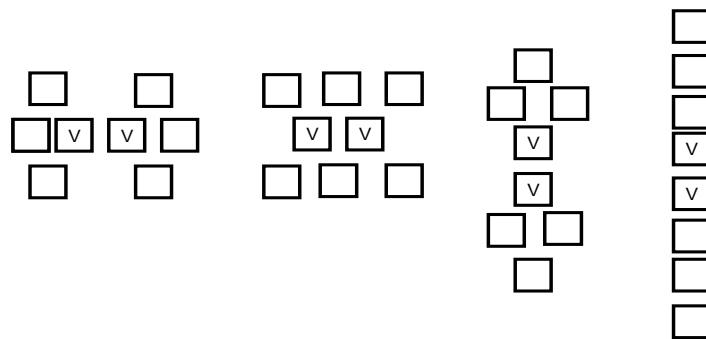

Starting Formations

Each call's definition includes a list of possible starting formations for that call. Since there's no way to list every formation a call can start from, we don't mean to restrict you to those formations. However, this isn't a license to shoehorn a definition into an oddball formation. Following the guidelines below will lead you to other legitimate starting formations; anything else should be avoided.

- The formations listed are usually the smallest from which the call can be done. Larger formations may be made of these smaller units. For example, Switch to a Diamond is defined to start from a single ocean wave, so it can also be done from parallel waves [*ending in parallel diamonds*], or from a tidal wave [*ending in point-to-point diamonds*].
- Where they apply, you can use the general rules (Facing Couples, Ocean Wave) to find other starting formations. For instance, Pass and Roll can start from a right-hand box circulate formation even though that formation doesn't appear in the definition's list: The Ocean Wave rule applies.
- If the word "only" appears in the list, then only the formations listed may be used. You may not apply the Facing Couples or Ocean Wave rules. One call like this is Recycle—the facing-couples definition is not applicable from an ocean wave.
- If the way you plan to use a call requires that two conflicting rules apply, your usage is improper. For example, using the call Cast a Shadow from lines back to back causes a conflict for the ends—they are both leads, and each must meet the other with his inside hand. At the same time, the right-shoulder rule applies. Because of this conflict, that use of Cast a Shadow is improper.
- If the formation you call the call from, can be broken into two different starting formations for the call, you have to specify which you mean. For example, the call Dixie Style to a Wave can start either from facing couples or from facing tandems. If it is called when the dancers are in a double pass thru formation, they don't know which formation to start the call from—it could be done either way. In cases like this, you must tell the dancers which one you want: either "Centers Dixie Style to a Wave", or "On the double track, Dixie Style to a Wave".

Glossary of Descriptive Terms Used in the Definitions

For convenience, we've used some terms which haven't been formally defined before. Again, we've tried to use terms which are common at Advanced. This is a list:

Face In: Means "Turn 1/4 in place, turning toward the center of the set."

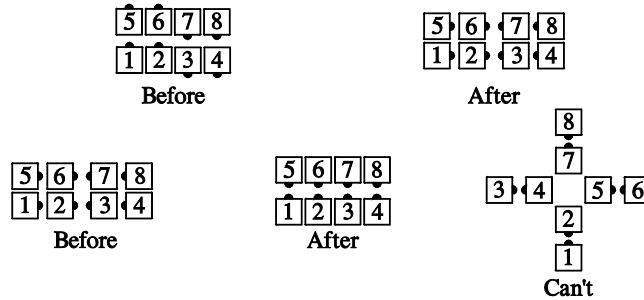

Face Out: Means "Turn 1/4 in place, turning away from the center of the set."

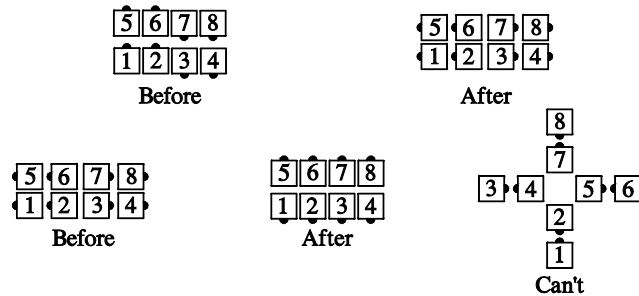

Line: Unless otherwise specified, the term line means any kind of 4-dancer line—one-faced, two-faced, three-and-one, inverted, etc.

Touch: This is the same as saying step to an ocean wave: The dancers step forward to join right hands, making a right-hand mini-wave.



Touch 1/2, 3/4: Fractions other than 1/4 are allowed with Touch. For example, the call "Touch 1/2" is the same as "Touch and Trade." In the same way, "Touch 3/4" is "Touch and Cast Off 3/4:"

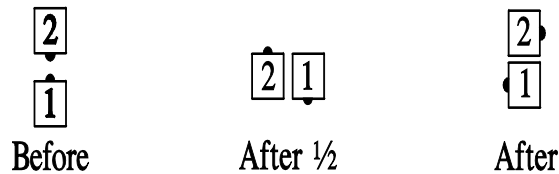

Cast Off 1/4, 1/2: Fractions other than 3/4 are allowed with Cast Off. The rule is the same as for Cast Off 3/4, but the dancers move 1/4 or 1/2 instead of going the full 3/4.

Left: The modifier "Left" applies to calls and interchanges right with left and, if also applicable, belle with beau (and also clockwise and counterclockwise). Left should only be used to modify calls where a right hand turn or shoulder pass is clearly part of the definition. The Left modifier is usually used with calls that start with one of the following:

- Right Pull By (e.g. Left Square Chain Thru, Left Split Square Thru)
- Pass Thru or passing action (e.g. Left Dosado, Left Pass and Roll, Left Track II, Left Wheel and Deal from a One-Faced Line)
- Tag The Line (e.g. Left 3/4 Tag, Left Turn and Deal)
- Right Arm Turn (e.g. Left Swing Thru, Left Turn Thru)
- Turn [a fraction] by the Right (e.g. Left 1/4 Thru, Left Remake)
- Touch (e.g. Left Touch 1/4, Left Spin the Windmill)

- g) Turn to the right (e.g. Left Wheel Thru, Left Roll to a Wave, Left Chase)

To apply the Facing Couples Rule to a "Left" call, dancers first Step To A Left-Hand Wave (e.g., Left Swing Thru, Left Relay the Deucey, Left 3/4 Top).

If a different modifier can perform the same function as the Left modifier (e.g., Wrong Way Promenade, Reverse Flutterwheel), then Left should not be used. Also see "Reverse", below.

The Left modifier does not affect other directions that are explicitly given. E.g., in Left Spin the Windmill Right, the outsides go right. (The Left only applies to the centers; this use of Left is only necessary for Facing Couples.)

At Advanced, the left versions of the calls are part of the program even when they are not explicitly listed.

Reverse: The modifier "Reverse" applies to certain calls and interchanges Beau and Belle and the directions of clockwise and counterclockwise (and also right and left). At Advanced, dancers are expected to apply Reverse to the calls listed below, and other applications of Reverse should be workshopped or avoided.

- a) Rollaway
- b) Half Sashay
- c) Wheel Around
- d) Courtesy Turn
- e) Flutterwheel
- f) Dixie Style to an Ocean Wave
- g) Circle to a Line
- h) Single Circle to a Wave
- i) Swap Around
- j) Recycle (from Facing Couples)

Formation Isn't There

Sometimes the definitions call for a dancer to do "his part of" some call—even when the formation he's working in exists only in the mind's eye. For example, in the call Switch to a Diamond, the ends of the wave Diamond Circulate even though there's no diamond. Similarly, in Flip the Hourglass, the points Run as though they were in parallel lines. The cases we used are shown below; in each diagram, the corresponding positions in the corresponding formations are labeled alike. Unlabeled dancers have no corresponding places.

The ends of parallel lines or waves may act like the points of an hourglass. Similarly, the points of an hourglass may act as though they were the ends of parallel lines:

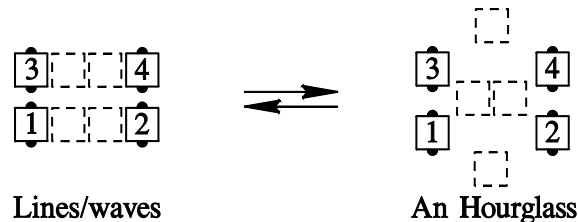

The points of a diamond may act like the ends of a line, or vice versa. The centers of a diamond may act like the centers of a line, or vice versa:

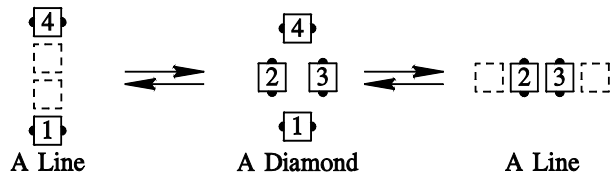

The very center two in any formation may act like the centers of an hourglass, and vice versa. Any outsides who are on a center line may act as the other centers of an hourglass, and vice versa:

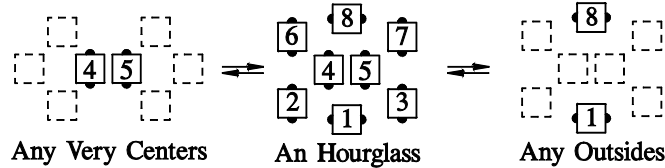

A wave between vertical mini-waves may be treated as a thar:

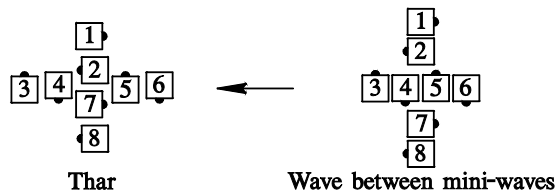

How Mainstream Calls Are Extended at Advanced

Several calls are used in limited ways at Basic, Mainstream and Plus; at Advanced, they are used from more places, or are defined more generally.

Extend: At Advanced, this call is allowed from double pass thru, 1/2 tag, box circulate, or 3/4 tag: All move forward to the next tag position, as shown below:

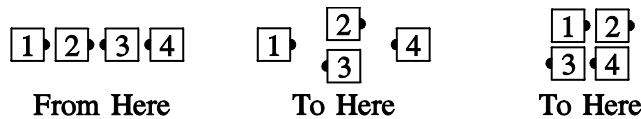

Or:

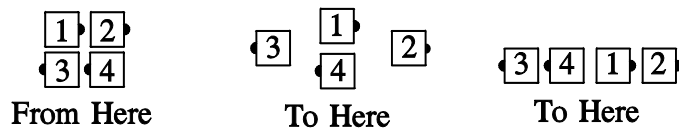

If you are in a left-handed formation, the result is also left-handed:

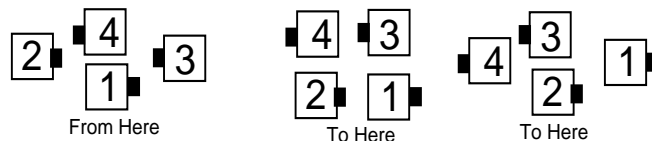

Tag the Line: The Mainstream definition is unclear on whether this call is permitted from an ocean wave. At Advanced, it is.

Doing your part: At Advanced, the caller can have dancers do their part of a call—even when the complete starting formation isn't there. The caller doesn't have to say "do your part"—it can be implied.

A-1 Definitions

Any Hand Concept

This concept is used with calls that start with the right hand and are defined as a series of turns (e.g., Swing Thru, 1/4 Thru, Remake).

Starting formation: Inverted Line or Inverted Box; **every pair** of dancers must be in a right or left-hand mini-wave.

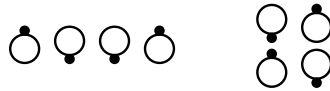

Inverted Line Inverted Box

Dance action: Dancers start by having everyone in a mini-wave (pair) turn by either the right or left hand the appropriate amount. The call continues, with the following modifications as necessary:

- Turn 1/4 - if in a couple, use Cast Off 1/4
- Turn 1/2 - if in a couple, use Partner Trade
- Turn 3/4 - if in a couple, use Cast Off 3/4

For example, after a Heads Square Thru 4, Centers In, the call Any Hand Swing Thru would have all dancers turn half (some by the right and some by the left) and the new centers Partner Trade to end in Facing Lines.

The Facing Couples Rule does not apply with this concept.

Example #1: Any Hand Swing Thru

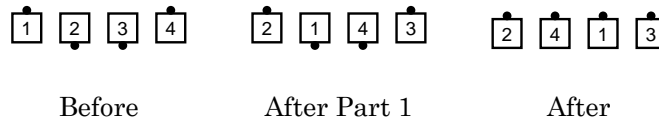

Example #2: Any Hand 1/4 Thru

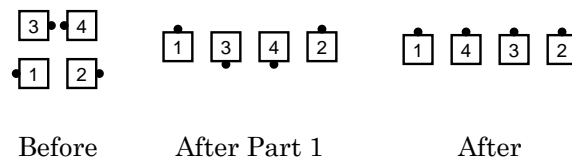

Example #3: Any Hand 3/4 Thru

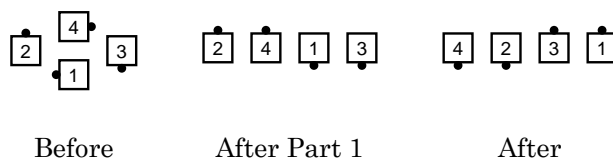

Example #4: Any Hand Remake

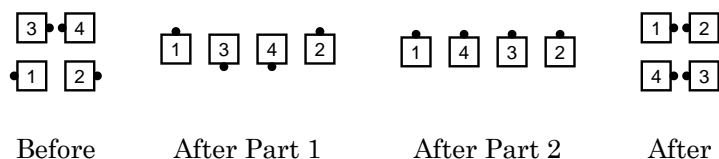

(Anything) and Cross / (Named Dancers) Cross

(Anything) and Cross

Timing: call + 2

From any appropriate formation: Do the "Anything" call. Trailers diagonally Pull By with each other, using their outside hands. For example, Touch 1/4 and Cross:

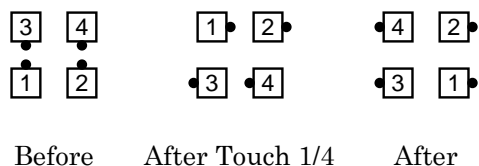

The "Anything" call must end in a 2x2 formation with two leaders, and two trailers who are facing each other on a diagonal (e.g., box circulate).

(Named Dancers) Cross

Timing: 2

Any formation in which the designated dancers are facing on a diagonal: The named dancers then diagonally Pull By with each other, using their outside hands. Ending formation: various. For example, Wheel and Deal, Beaus Cross:

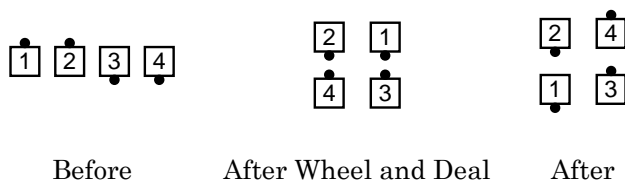

As Couples Concept

Timing: --

From any formation composed only of couples, for example double pass thru, facing lines, or parallel two-faced lines: This is used to modify a call, e.g., As Couples Walk and Dodge from parallel two-faced lines. Each couple acts as though it were a single dancer, and does the part of the call appropriate to its position in the starting formation.

For example, the diagrams below show As Couples Walk and Dodge. Each couple (left diagram) works as a unit, and the dancers act as though they were in a box circulate formation (center diagram). The couples facing in, take the part of single dancers facing in, and the couples facing out, take the part of single dancers facing out. The result is as shown:

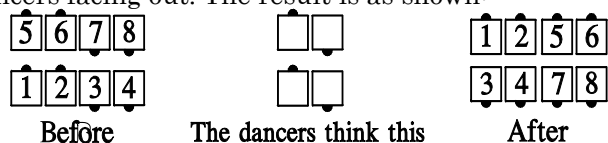

For Teaching: No one should let go of his partner during an As Couples call.

Belles and Beaus (naming convention)

In a couple, the dancer on the left is the "beau" and the dancer on the right is the "belle".

Brace Thru (formerly Half Breed Thru)

Timing: 6, SS 8

From facing couples, each composed of a man and a woman: All Right Pull By. Those dancers (if any) in a normal couple Courtesy Turn to end facing the other couple. Those in a half sashayed couple U-Turn Back, turning toward each other. Ends in normal facing couples.

Note: In 2012 the name of this call was changed from Half Breed Thru to Brace Thru. The new name was chosen because the final action is the call Brace Yourself (which is not on the Advanced program).

Cast a Shadow

Timing: 10

From the following formations only:

- 2x4 with the ends forming a tandem
- Promenade or Wrong Way Promenade

From a 2x4 formation with the ends forming a tandem: ends 1/2 Zoom, Arm Turn 3/4, and Spread to become ends of a 2x4. Meanwhile centers facing out Cloverleaf and centers facing in Extend, Arm Turn 1/4, and Extend. The centers finish as centers of a 2x4 by stepping in between ends who spread apart. In the case in which all the centers are facing in, they Pass In and Pass Thru; if all centers are facing out, they Cloverleaf.

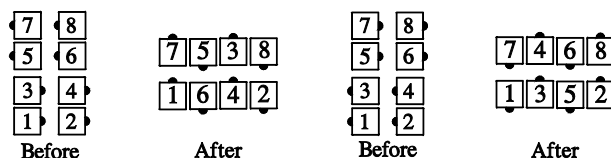

From Promenade or Wrong Way Promenade: The caller must designate two couples, e.g., Heads Cast a Shadow. Everyone acts as though the formation were Two-Faced Lines, with the designated couples as the leaders. Thus, the outsides 1/2 Zoom (with the designated outside acting as the lead), Arm Turn 3/4, and Spread, while the designated centers Cloverleaf, and the other centers Arm Turn 1/4 and Extend. Ends in Parallel Waves.

Note: Cast a Shadow is not proper from Columns because the ends are not in tandem with each other.

Chain Reaction

Timing: 12

From any quarter tag or quarter line formation in which each very center can Pass Thru with an outside dancer. [At Advanced, this call is restricted to starting from right- or left-hand quarter tag formations only]: The very centers Pass Thru with the dancers they are facing, while the ends of the center line/wave Promenade 1/4 around the outside of the set. The original very centers and the dancers they are next to, Hinge. The centers Star (or Diamond Circulate) one spot, while the outsides Trade. Those who meet now Cast Off 3/4, while the others move up (very centers along an outward diagonal, and very ends along a quarter circle) to become the ends of parallel waves.

Example:

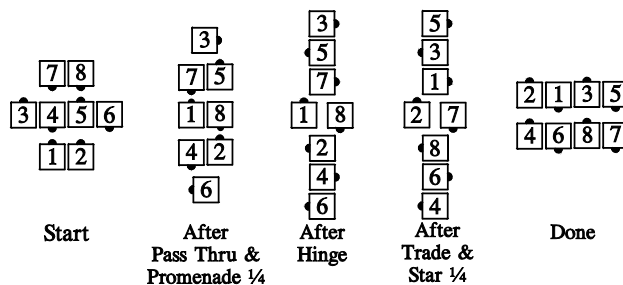

Or:

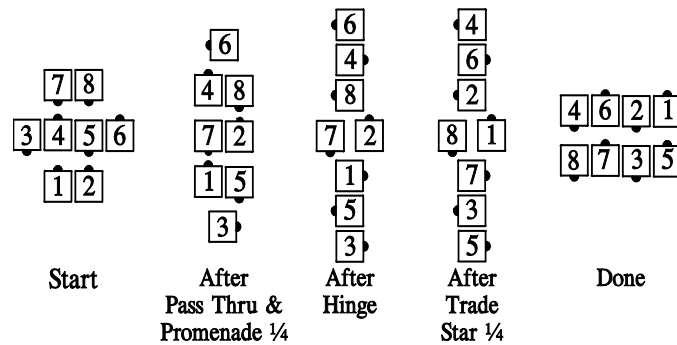

Clover and (Anything) / Cross Clover and (Anything)

Clover and (Anything)

Timing: Greater of 4 or the call

From any formation in which 2 couples are facing out and can do a Cloverleaf (e.g., trade by formation): Those facing out Cloverleaf, while the others do the Anything call (after moving to the center, if necessary).

Cross Clover and (Anything)

Timing: Greater of 10 or the call

From any formation in which 2 couples are facing out and can do a Cloverleaf (e.g., trade by formation): Those facing out Half Sashay blending into a Cloverleaf, while the others do the Anything call.

Cross Over Circulate

Timing: 6

From general lines only: Each dancer moves forward one spot along the circulate path shown below: A lead end Circulates to the far center spot in the same line; a lead center Circulates to the far end spot in the same line; a trailing end Circulates to the near center spot in the other line, and a trailing center Circulates to the near end spot in the other line. If two dancers are about to collide and they are facing the same direction, the belle goes in front of the beau; if they are facing each other, they pass right shoulders.



Examples:

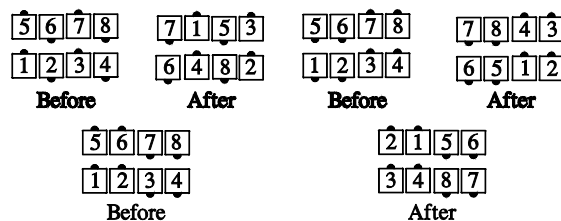

For Teaching: You can describe this as: Leads Cross Run as trailers (do their part of) Couples Circulate and Half Sashay as they go. However, it is far more effective to re-introduce the idea of circulate paths (already used at Basic), and use it to describe the call.

Cross Trail Thru

Timing: 6, SS 6

From facing couples: As one smooth motion, Pass Thru and Half Sashay. Ends in couples back-to-back.

Note: When one hears "Cross Trail Thru To Your Corner; Allemande Left", the Cross Trail Thru is danced, as one smooth motion, Pass Thru and left-shoulder Partner Tag.

Cycle and Wheel

Timing: 4

From a 3-and-1 line: The dancers in the mini-wave do a Recycle while the couple does a Wheel and Deal. If the ends of the line are facing opposite directions, this will end in couples facing. If the ends are both facing the same direction, the right end must pass in front, to end in tandem couples.

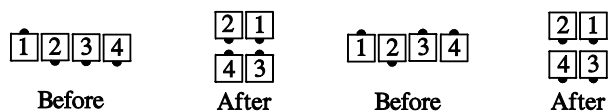

Double Star Thru / Triple Star Thru

Double Star Thru

Timing: 6

From any appropriate formation (e.g. Normal Facing Couples): Those who can Star Thru. Those who can do the mirror image of a Star Thru (an arch is made with the man's left hand and the woman's right hand; the man goes around the arch while the lady goes under). In each part of the call, some dancers must be active. Normal facing couples will end as sashayed couples back-to-back.

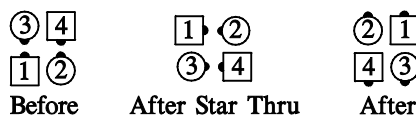

Triple Star Thru

Timing: 10

From any appropriate formation (e.g., Double Pass Thru with normal couples in the center and outsides sashayed): Those who can Star Thru. Those who can do the mirror image of a Star Thru (as in Double Star Thru). Those who can Star Thru. In each part of the call, some dancers must be active.

For Teaching: The lady always goes under the arch.

Ends Bend

Timing: 2

From any formation with the ends in a line: The ends do their part of a Bend the Line. Note that dancers can Roll after this call.



For Teaching: This can be described as half of a Run.

Explode and (Anything)

Timing: 2 + call

From a wave: All Step Thru (giving couples back-to-back), Quarter In, and do the "anything" call.

From a general line with both centers facing the same direction: The centers step ahead as the ends slide together. All Quarter In to make facing couples and do the anything call.

Note: The call Explode is not meant to be used alone; only as the preface in this call. It is not used as short-hand for Explode the Line or Explode the Wave. After Explode And, every dancer is able to Roll.

Explode the Line

Timing: 6

From a general line with the centers facing the same way: The centers step forward as the ends slide together. Then all Quarter In and Right Pull By. Ends in couples back-to-back.

Fractional Tops

Timing: 4-6-8

From a Thar or Wrong-Way Thar: All Arm Turn 1/2, then the centers turn their star, as the outsides move forward around their circle, and for—

Quarter Top end upon meeting the first dancer.

Half a Top end upon meeting the second dancer.

Three Quarter Top end upon meeting the third dancer.

Ends in a thar or wrong-way thar.

Grand Follow Your Neighbor

Timing: 6

From Columns: The #1 dancer in each column does the leads' part of Follow Your Neighbor ("Fold and Roll"). The #2, 3, and 4 dancers do the trailers' part of Follow Your Neighbor (Extend and Cast Off 3/4). Ends in a tidal wave.

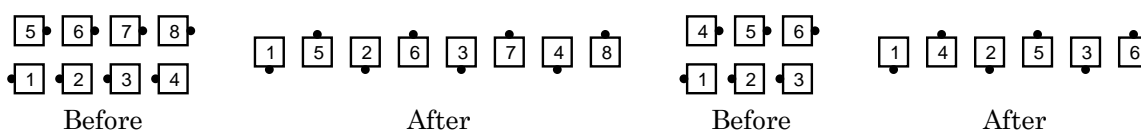

You can also do Grand Follow Your Neighbor and Spread:

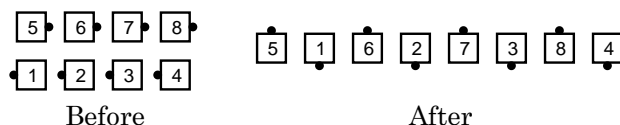

Horseshoe Turn

Timing: 6

From anywhere the outsides can Cloverleaf and the centers can Partner Tag (e.g., completed double pass thru): Clover and the centers Partner Tag.

Lockit

Timing: 4

From a general line or diamond, with the centers in a mini-wave only: Centers Arm Turn 1/4, while the ends move up around a quarter circle, as in Fan the Top.

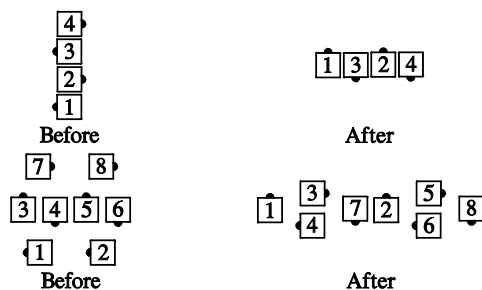

Mix

Timing: 6

From a general line: Centers Cross Run, then the new centers Trade. If both centers are facing the same way at the start of the call, they Half Sashay, blending into a Run around the original far end.

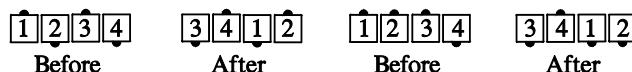

Pair Off

Timing: 2, SS 4

From facing dancers, neither of whom is facing the flagpole center of the set, only. Dancers face out to end as a couple. From a static square, the designated dancers will first step forward into the center.

Partner Hinge

Timing: 2

From a couple only, Hinge, finishing in a right-hand mini-wave at right angles to the original couple, with the new handhold centered on the original handhold.

Partner Tag

Timing: 3

From a couple or mini-wave, dancers turn to face each other and pass thru.

Pass In/Out**Pass In**

Timing: 4

From facing dancers (e.g., facing lines, or eight chain thru): All Pass Thru and Face In.

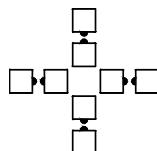

Note that the dancers shown below cannot Face In after the Pass Thru, and so cannot Pass In.

**Pass Out**

Timing: 4

From facing dancers (e.g., facing lines, or eight chain thru): All Pass Thru and Face Out.



Note that the people in the bottom diagram shown under Pass In (those who could not do the Pass In) also cannot Pass Out.

Pass the Sea

Timing: 6

From facing couples: All Pass Thru, Quarter In, and Left Touch.



Quarter In/Out

Quarter In

Timing: 2

From anywhere partner is defined, or the call Face In can be done: Turn 1/4 in place to face your partner. If you have no partner (as in a diamond), then Face In toward the center of your half of the set.

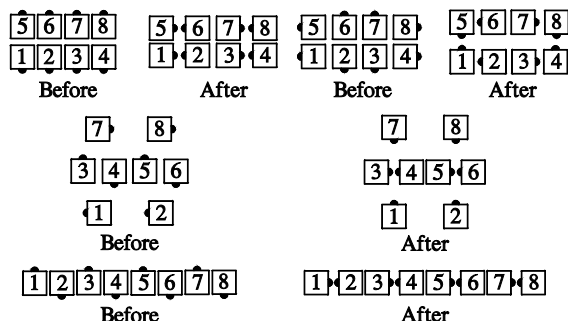

Quarter Out

Timing: 2

From anywhere partner is defined or the call Face Out can be done: Turn 1/4 in place, turning away from your partner. If you have no partner (as in single file promenade), then Face Out from the center of your half of the set.

Quarter Thru / Three Quarter Thru

Quarter Thru

Timing: 6

From any appropriate 4-dancer formation (e.g., right-hand box circulate, left-hand facing diamond): Those who can Turn 1/4 by the Right, then those who can Turn 1/2 by the Left.

There must be dancers who can do both parts of the call. The call is not proper from an Inverted Box.

If there are two side-by-side formations each of which can do the call, dancers don't move from one to the other. From right-hand columns, for example, each of the two box circulate formations does the call independently.

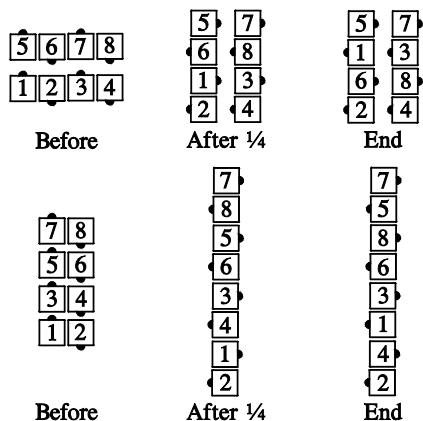

Three-Quarter Thru

Timing: 8

From any appropriate 4-dancer formation (e.g., right-hand box circulate, left-hand facing diamond): Those who can Turn 3/4 by the Right, then those who can Turn 1/2 by the Left.

See the notes under Quarter Thru.

Grand Quarter Thru / Grand Three Quarter Thru

Grand Quarter Thru

Timing: 6

From right-hand columns (of 6 or 8): Those who can Turn 1/4 by the Right, then those who can Turn 1/2 by the Left.

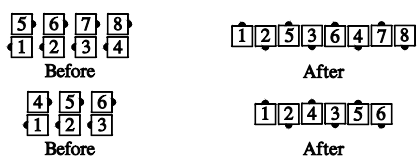

There must be dancers who can do both parts of the call. The call is not proper from Magic Columns.

Grand Three-Quarter Thru

Timing: 8

From right-hand columns (of 6 or 8): Those who can Turn 3/4 by the Right, then those who can Turn 1/2 by the Left.

There must be dancers who can do both parts of the call. The call is not proper from Magic Column.

Right (Left) Roll to a Wave

Right Roll to a Wave

Timing: 4 & 2

From dancers back-to-back, or a tandem: The leads right-face U-Turn Back, and all Touch.

Left Roll to a Wave

Timing: 4 & 2

From dancers back-to-back, or a tandem: The leads left-face U-Turn Back, and all Left Touch.

Scot and Dodge

Timing: 8

From box circulate only: The trailers Scot Back, while the leaders Dodge (as in Walk and Dodge).

Six-Two Acey Deucey

Timing: 4

From anywhere with a very center two, and an outside 6: The very centers Trade, while the outside six Circulate in their formation.

For common formations, the circulate paths for the outside six are shown below:

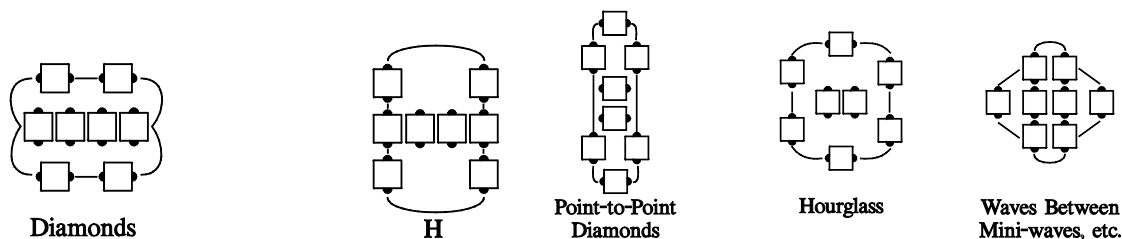

Split Square Chain Thru

Timing: 12

From a static square, or T-bone. (From a static square, those designated step forward, to form two side-by-side T-bones.): Those facing Right Pull By, Quarter In (to face those who didn't pull by), all Left Swing Thru, and Left Turn Thru. Finishes in couples back-to-back.

Split Square Thru

Timing: 6-8-10, SS 8-10-12

From a static square, or T-bone. (From a static square, those designated step forward, to form two side-by-side T-bones.): Those facing Right Pull By, Quarter In (to face those who didn't pull by), and all Left Square Thru 3/4.

Can also be done fractionally, or for a given number of hands. In these cases, the fraction applies to those who start the call, e.g., for a Split Square Thru 3/4, the dancers who start facing do a total of 3 Pull Bys, and the other two dancers do 2 Pull Bys.

Square Chain Thru

Timing: 14

From facing couples: All Right Pull By, Quarter In, Left Swing Thru, and Left Turn Thru, to end in couples back to back.

Step and Slide

Timing: 4

From a general line: Centers step forward, while the ends slide sideways until they are adjacent.

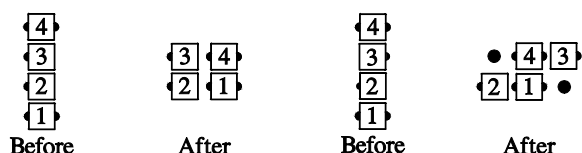

Swap Around / Reverse Swap Around

Swap Around

Timing: 4

From facing couples: The belle in each couple walks straight forward without turning, to take the spot of the dancer s/he was facing. At the same time, the beau in each couple Runs (passing behind his starting partner) into the spot being vacated. Ends as couples back to back.

Reverse Swap Around

Timing: 4

From facing couples, the beaus walk (as in Walk and Dodge) while the belles run to the left.

Transfer the Column

Timing: 10

From columns: The #1 and #2 dancers Circulate 3 spots, working slightly wider than usual to give the centers room, and Face In (to become a Couple). Meanwhile, the #3 and #4 dancers Circulate and Arm Turn 3/4. From the momentary right-hand or left-hand 1/4 Tag, all Extend to form parallel waves.

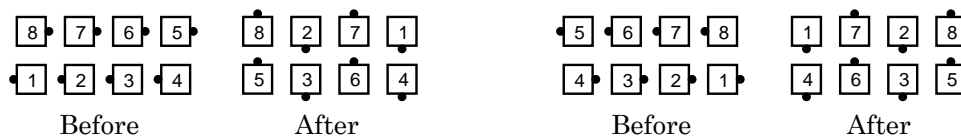

Triple Cross

From columns: The 6 dancers who can, will pull by on the diagonal, using outside hands.

Triple Scoot

Timing: 6

From Columns: Dancers facing each other on a diagonal (three pairs) step forward to join adjacent forearms, turn one-half (180 degrees) and step forward to finish in a position vacated by the dancer who was originally adjacent to them in the column. Meanwhile, the #1 dancer in each column Runs into the position vacated by the adjacent #4 dancer who is doing the forearm turn. When done from right-hand columns, the dancers facing in turn by the right. When done from left-hand columns, the dancers facing in turn by the left hand.

Triple Trade

Timing: 4

From tidal waves, tidal two-faced lines, point-to-point diamonds, six-dancer ocean wave, or any 3 pairs of adjacent dancers: The two end dancers remain in place as the three adjacent pairs of dancers (the six in the center) Trade with each other.

Turn and Deal

Timing: 4

From a general line: As one smooth motion, all Half Tag, then turn individually another quarter in the same direction you turned to start the Half Tag. This call is considered to have a single part; it cannot be fractionalized.

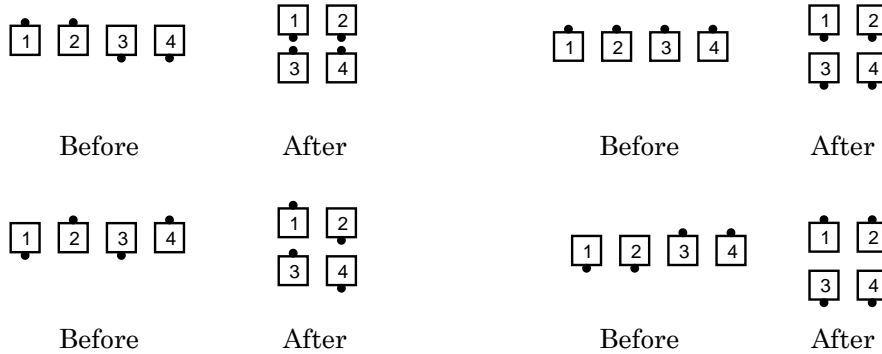

Wheel Thru / Left Wheel Thru

Wheel Thru

Timing: 4, SS 6

From facing couples: Similar to Couples Lead Right, except that the dancers drop hands and the beaux pass right shoulders with each other on the way. Ends in couples back-to back.

Left Wheel Thru

Timing: 4, SS 6

From facing couples: Similar to Couples Lead Left, except that the dancers drop hands with each other, and the belles pass left shoulders with each other on the way. Ends in couples back-to back.



A-2 Definitions

All 4 Couples / All 8 Concepts

Timing: various

From the general versions of static square, circle, and Thar: These concepts are applied to 4-dancer calls, and allow all eight dancers to do the call at once. Each group of 4 dancers work with themselves as though the other group wasn't there.

When the dancers would normally walk through the middle of the square (e.g. as part of a Pass Thru or Pull By), they walk around the perimeter instead. All the hand actions and shoulder passes are the same as for the basic call. However, passing the other dancers (e.g., heads passing sides) alternates between right shoulders and left shoulders. An example of this shoulder passing can be found in All 4 Couples Right and Left Thru.

When two dancers would normally walk through the center of the square (e.g. as part of a centers Pull By or centers arm turn), they still go through the center--they adjust into a star as they go, to avoid collisions. Examples of this can be found in All 8 Swing Thru and All 8 Dixie Style To A Wave.

Some calls contain both traffic patterns. From a squared set, All 4 Couples Square Chain Thru would be danced as a pass your corner right shoulder, Right Pull By, pass the next left shoulder, step to left-hand wave with the next, all arm turn 1/2 by the left, center 4 star 1/2 by the right, all left turn thru and pass the next left shoulders. Ends in a squared set with everyone facing out. The dancers who started on the head spots are now on the side spots.

At the end of the call, you must adjust to the nearest static square footprints of the wall you are facing. For example, if you end facing the head walls, adjust (without turning) to the nearest head position. If you end on Thar spots, you don't adjust.

The initial traffic pattern determines the name of the concept. If the initial traffic pattern requires all dancers to walk around the perimeter, "All Four Couples" is used. Otherwise, "All Eight" is used.

All 4 Couples Chase Right

Timing: 10

From a static square with everyone facing out, those at the head position Chase Right while those at the side position also Chase Right. All action is clockwise around the outside of the set. Ends on static square spots with dancers in right-hand mini-waves.

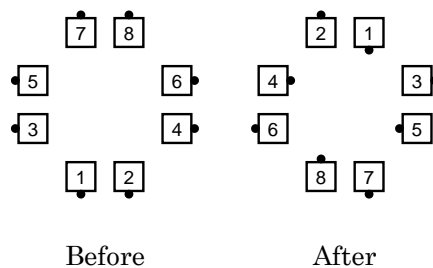

All 4 Couples Right and Left Thru

Timing: 10

From a static square or circle: All pass corners right shoulders, Right Pull By with opposite, pass the next dancer left shoulders, and Courtesy Turn with partner, to end facing the center of the set.

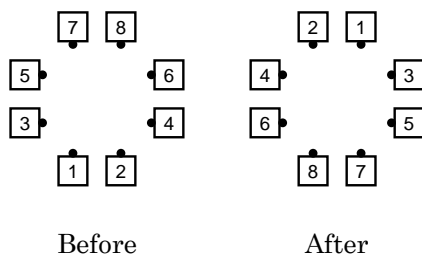

All 4 Couples Star Thru, etc.

Timing: 6

From a square or circle: All pass corner right shoulders, Star Thru, etc. For example, All Four Couples Touch 1/4:

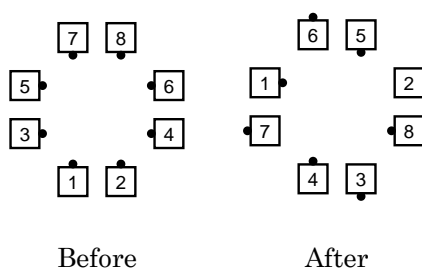

All 8 Dixie Style To A Wave

Timing: 8

From a static square, the right hand dancers step forward and to the left to become the lead dancer in a tandem. Lead dancers join right hands in a star and Pull By. All Left Touch 1/4. Ends in a Thar Star.

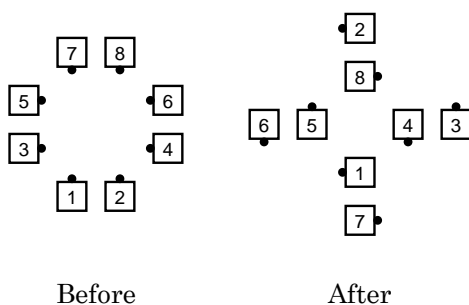

All 8 Mix

Timing: 10

From a Thar or Wrong Way Thar, the centers cross run, by turning their star 1/2 and sliding nose-to-nose with the outsides (Slide). The new centers trade, by turning their star 1/2. Ends in a Thar or Wrong Way Thar.

All 8 Swing Thru

Timing: 8

From a Wrong Way Thar, all arm turn 1/2 by the right. Center 4 star 1/2 by the left. Ends in a Wrong Way Thar.

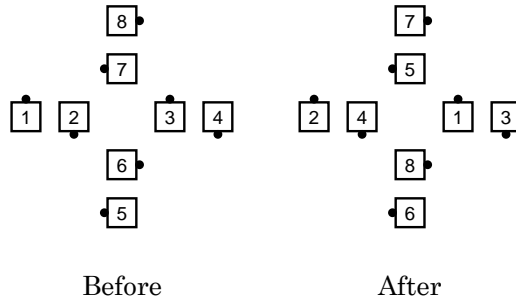

All 8 Walk and Dodge

Timing: 6

From a static square with everyone in a mini-wave, those facing in walk forward across the set to take the place of the dancer who was directly in front of him. Those facing out step sideways into the position vacated by the "walker". Ends in a static square with everyone facing out. If all the "walkers" move at the same rate, there will be a momentary star 1/2 way through the call.

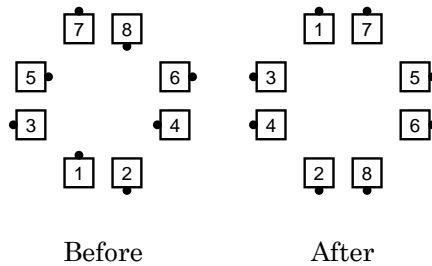

Teaching hints to tell the dancers:

1. Based on the call, identify the 4 dancers whom you will work with.
2. Do the call as if the other 4 dancers weren't there. Avoid colliding with them either by using a star when you go through the middle or passing them on the perimeter.
3. At the end of the call you must adjust (without turning) to the nearest static square footprints of the wall you are facing.
4. If you end on Thar spots, you don't adjust.

Checkmate the Column

Timing: 10

From columns: Numbers 1 and 2 in each column Circulate 4 spots and Face In, while numbers 3 and 4 Circulate twice, Face In, and as a couple Circulate. Ends in parallel two-faced lines.



Diamond Chain Thru

Timing: 10

From diamonds: All Diamond Circulate, the very centers Trade, and Cast Off $\frac{3}{4}$ with the adjacent ends of the wave. Ends in parallel waves or lines.

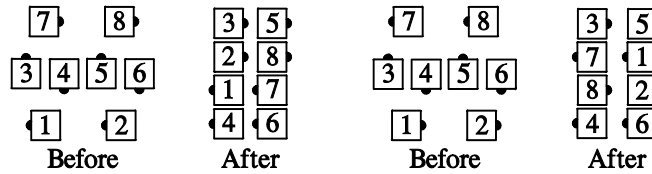

Hourglass Formation:

Hourglass Circulate

Timing: 4

From an hourglass: Each dancer does a Circulate by moving forward one position in the hourglass, to take that dancer's place. Dancers move along the path shown:

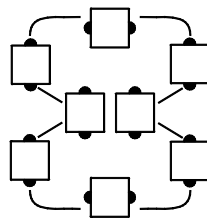

Points become centers, and centers become points. Also, the diamond dancers move to the box, and the box dancers move to the diamond.

For Teaching: Tell each dancer to move up to the next person's spot in the hourglass, taking his footsteps. During this call, everyone keeps the same shoulder toward the center of the set. This is a good call for using a demonstration square.

Cut/Flip the Hourglass

Cut the Hourglass

Timing: 6

From an Hourglass: The points slide together and Trade, while the others Hourglass Circulate. Ends in parallel lines or waves.

Flip the Hourglass

Timing: 4

From an hourglass: The points Run to the nearest center (Flip in as for Flip the Diamond), while the others Hourglass Circulate.

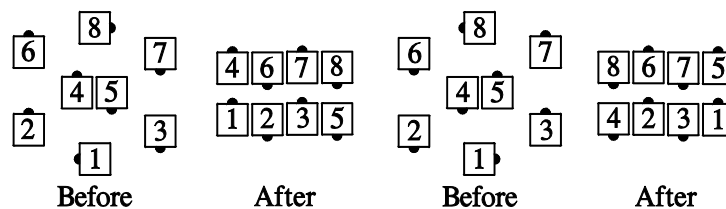

In/Out Roll Circulate

In Roll Circulate

Timing: 4

From general lines, with the ends forming a tandem: In each line, the end facing in Circulates. Meanwhile, each of the other dancers (in a single, smooth motion) faces the vacated spot, steps forward, and turns another 1/4 the same way he first turned. Ends back in parallel lines or waves.

The non-circulators' part is a single motion, rather than a 3-part move. This call can be fractionalized into halves, as shown below.

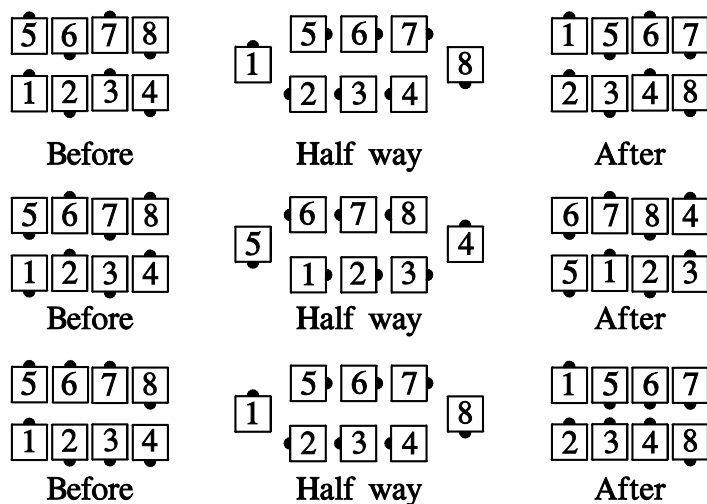

For Teaching: You can describe the non-circulators' part as a Run (or Flip) toward the vacated spot. This captures the idea of a single, flowing motion for them.

Out Roll Circulate

Timing: 6

From general lines, with the ends forming a tandem: In each line, the end facing out Circulates. Meanwhile, each of the other dancers, in a single, smooth motion, faces the vacated spot, takes a step forward, and turns another 1/4 in the same direction he first turned. Ends back in parallel waves or lines.

The non-circulators' part is a single motion, rather than a 3-part move. This call can be fractionalized into halves, as shown below.

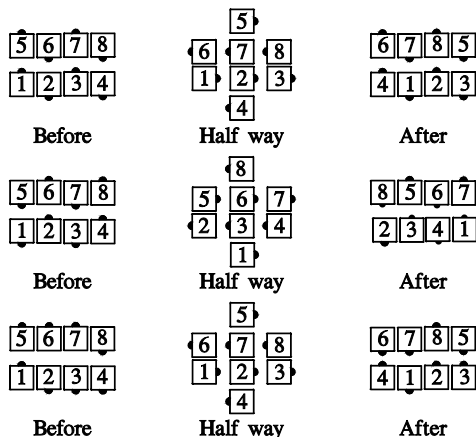

For Teaching: You can describe the non-circulators' part as a Run toward the vacated spot. This captures the idea of a single, flowing motion for them.

Mini-Busy

Timing: 6

From parallel two-faced lines: The trailers As Couples Extend, have the center two Hinge, and Flip the Diamond. Meanwhile, the lead couples (working around the outside) Face In, step forward one spot, and Face In. Ends in a quarter-tag formation. This call has three parts, as illustrated below:

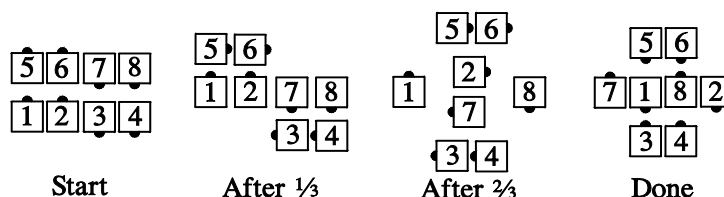

Motivate

Timing: 16

From waves: All Circulate, the centers of each wave Cast Off 3/4 while the ends Circulate 1/2, to create a star between two mini-waves. The star turns half, while those in the mini-waves Trade. Those who meet Cast Off 3/4, while the others move up (as in Chain Reaction) to become the ends of parallel waves.

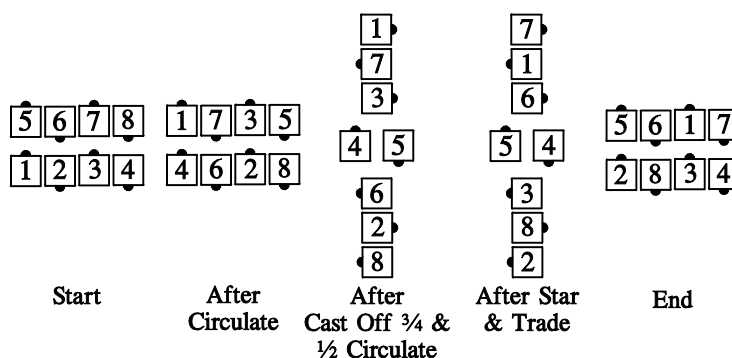

Pass and Roll

Timing: 10

From single eight chain thru: All Pass Thru; the centers Turn Thru, while the outsides do a right-face U-Turn Back. All Pass Thru, and the centers Pass Thru as the outsides do a Right Roll to a Wave to meet the centers. Ends in parallel mini-waves.

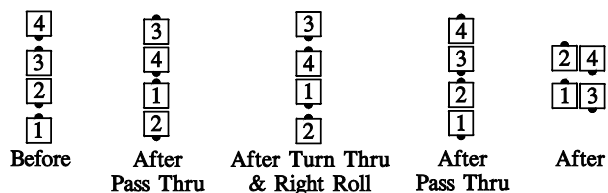

Pass and Roll Your Neighbor

Timing: 12

From single eight chain thru: All Pass Thru. The centers Turn Thru while the outsides do a right-face U-Turn Back. All Pass Thru, and the centers Touch 3/4 while the outsides finish as in Follow Your Neighbor (Fold right, Roll, and step slightly forward). Ends in a left-hand wave.

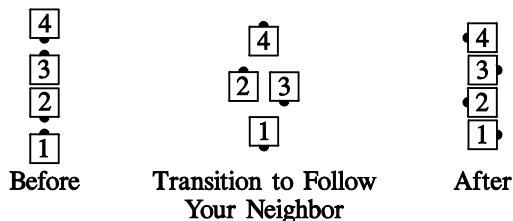

Peel and Trail

Timing: Tandem Couples - 4, Box Circulate or Z - 6

Starting formation: Tandem Couples, Box Circulate, or Tandem Dancers in a Z (e.g. from a wave after the Ends Fold)

Lead dancers do their part of a Peel Off turning away from the center of the formation and walking in an approximate semicircle to become the ends of a four-dancer line or wave. Trailing dancers do their part of a Trail Off stepping forward as necessary and walking in a small semicircle around the center point to become the centers of the forming line or wave. When the trailers are a Couple and must cross paths, the dancer on the right has the right-of-way so the Beau allows the Belle to cross in front (Half Sashay). When the trailers are facing opposite directions they step forward as necessary to the centerline and Trade with each other (using the same hand as the handedness of the formation).

As in Peel Off and Trail Off, always adjust to end in a four-dancer line or wave with each dancer having turned half (180 degrees). Peel and Trail, including all necessary adjustments, is danced as one continuous motion that cannot be fractionalized.

Peel and Trail from Tandem Couples will end in a One-Faced line. Peel and Trail from a Box Circulate or from a Right or Left Hand Z will end in an opposite-handed Wave.

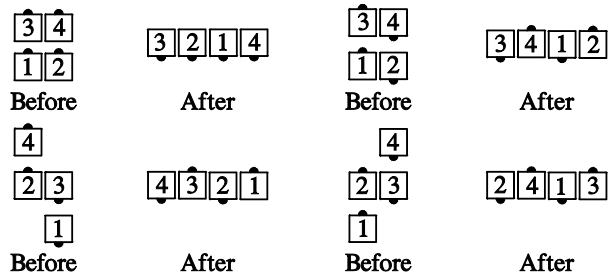

Notes:

Everyone can Roll after a Peel and Trail.

For the four dancers, the center of the ending formation is the same as the center of the starting formation; however, square breathing adjustments may reposition the whole line or wave.

When the trailers start facing in the same direction, their dance action feels like a Left Shoulder Partner Trade.

Recycle

Timing: 6

From facing couples only: The beaus step forward until they are side-by-side, while doing a U-Turn Back, turning toward each other. Meanwhile, the belles Veer Left and join right hands with the original beaus. Ends in a right-hand wave; the beaus finish as centers of the wave, and the belles finish as ends.



Remake Family

Remake

Timing: Alamo 12, others 10

From a right hand mini-wave box, or a left-hand facing diamond: Those who can Turn 1/4 by the Right, those who can Turn 1/2 by the Left, and those who can Turn 3/4 by the Right.

For each part of the call, there must be a dancer performing this part and the immediately preceding or following one. For example, the call is not proper from an Inverted Box.

The left-hand version of Remake is called "Left Remake".

The name of the formation may be added at the end of the call (e.g., Remake The Wave) as a help to the dancers but doing so is optional.

If there are two side-by-side formations, each of which can do the call, dancers don't move from one to the other. From right-hand columns, for example, each of the two box circulate formations does the call independently.

The exception to the remake rules is "Remake The Thar", defined below.

Grand Remake

Timing: 10

From right-hand columns (of 6 or 8): Those who can Turn 1/4 by the Right, those who can Turn 1/2 by the Left, and those who can Turn 3/4 by the Right.

For each part of the call, there must be a dancer performing this part and the immediately preceding or following one. For example, the call is not proper from Magic Columns.

The left-hand version of Grand Remake is called "Left Grand Remake".

Remake The Thar

Timing: 10

From a Thar or Wrong-Way Thar, end and adjacent center Arm Turn one-quarter (90 degrees) to form a momentary Alamo ring. In a continuously flowing movement, everyone releases holds with the dancer they just turned, and with the other hand, turn the next dancer one-half (180 degrees) to form another momentary Alamo ring. Without stopping, they release holds at the completion of the half turn and, with the other arm, turn the next dancer three-quarters (270 degrees) to form another Thar or Wrong-Way Thar.

Scout and Weave

Timing: 10

From right-(left-)hand box circulate only: Scout Back. Those facing in Left (Right) Touch 1/4 with each other, while those facing out Quarter Right (Left). Ends in a wave.

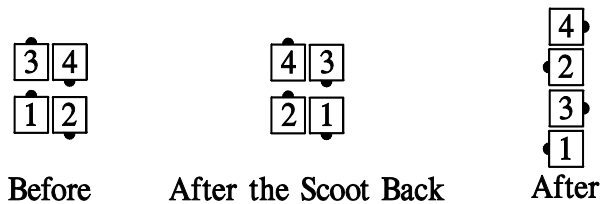

From single quarter tag: Extend, Trade, and then Weave the same way you would from box circulate.

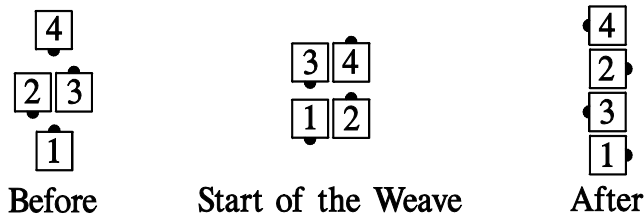

Scoot Chain Thru

Timing: 12

From waves only: Those facing out do a Scoot Back, while those facing in Extend, Swing, Slip, Swing, and Extend. Ends in waves.

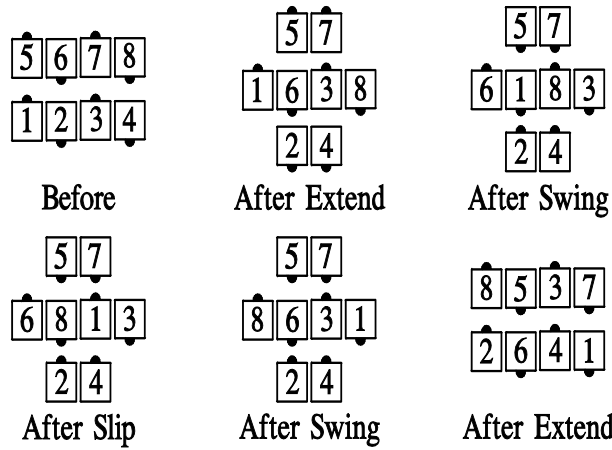

From quarter tag: All Extend, Swing, Slip, Swing, and Extend. Ends in three quarter tag.

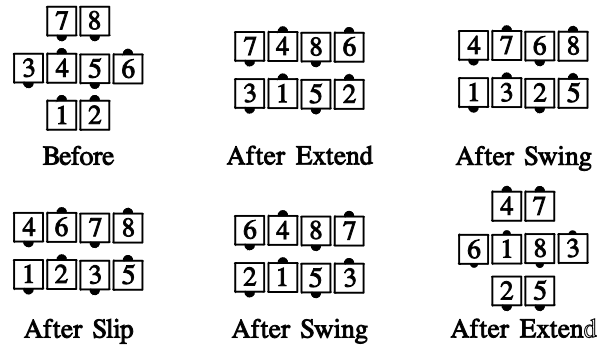

For teaching: The centers' part can be thought of as a Swing Thru 1 1/2 and Extend or Left Swing Thru 1 1/2 and Extend, depending on what hand was held in the wave.

Single Wheel

Timing: 4

From a couple or mini-wave only: With each dancer taking the part of an entire couple, do a Wheel and Deal. This call cannot be fractionalized.

For teaching: You can think of this as a Hinge and Roll. However, this call has only one part—it cannot be fractionalized.

Slip / Slide / Swing / Slither

Slip

Timing: 3

From a general line with the centers forming a mini-wave only: Centers Arm Turn 1/2 by the hand they have joined.

Slide

Timing: 3

From a general line in which each end and the adjacent center form a mini-wave only: Each end and the adjacent center slide nose-to-nose to take each other's place.

Swing

Timing: 3

From a general line with each end and the adjacent center in a mini-wave only: Each end and the adjacent center Arm Turn 1/2 by the hand they have joined.

Slither

Timing: 3

From a general line with centers in a mini-wave only: The centers slide past each other nose-to-nose, to take each other's place.

Spin the Windmill

Timing: 12

From anywhere with a center wave or center facing couples (e.g., 3/4 Tag, Trade By): Centers Swing, Slip, and Cast Off 3/4, while the outsides face as directed and Circulate two positions. If the centers start in facing couples, they first Touch, then finish the call.

Left Spin the Windmill is the same, except that:

- It may only be used with the centers in facing couples or a left-hand wave.
- If the centers are in facing couples, they Left Touch before doing the Swing, Slip, and Cast Off 3/4.

For teaching: You can describe the centers' part as Swing Thru and Cast Off 3/4, or as Left Swing Thru and Cast Off 3/4, depending on the handedness of the wave.

Split/Box Counter Rotate**Box Counter Rotate**

Timing: 4

From any 4-dancer formation with no dancers facing the flagpole center [*At Advanced, this call is used only from box circulate, and certain T-bone formations.*]: This call may have a fraction after it, such as Box Counter Rotate 3/4. If no fraction is given, it means Box Counter Rotate 1/4.

For each 1/4 in the fraction: Each dancer moves his position in the formation forward around the center of the formation 90 degrees by walking forward in a smooth arc to reach that spot. Each dancer works independently of the other 3 dancers in his formation.

Every dancer can Roll at the end of this call.

The diagrams below show the beginning and ending positions for a single dancer, for every spot in a box circulate formation: Example – Box Counter Rotate 1/4:

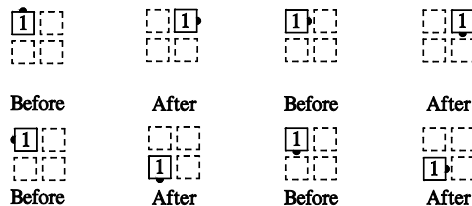

Example-Box Counter Rotate 3/4:

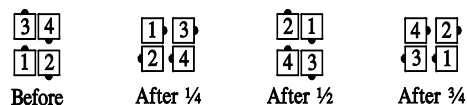

For Teaching: Think of this as Promenading 1/4 in the formation; that captures the smoothness of the call. You can also have the leads Quarter In and Box Circulate, while the trailers Box Circulate and Quarter In. That gets the dancers to the right place.

Split Counter Rotate

Timing: 4

From any applicable formation [*At Advanced, this call may be used from the following formations only: Any 2x4 formation, e.g., parallel waves, parallel columns.*]: Each half of the square does a Box Counter Rotate.

e.g., Split Counter Rotate 1/4:



Split/Box Transfer

Box Transfer

Timing: 8

From box circulate formation, or any symmetric 2x2 formation with 2 leaders and 2 trailers: Leads Box Circulate Twice and Quarter In, while the trailers Extend, Arm Turn 3/4, and Extend.



Split Transfer

Timing: 8

From waves or columns: Divide the whole formation into two side-by-side box circulate formations. Each of them Box Transfer.

Swing and Mix

Timing: 8

From an ocean wave or inverted line: ends and adjacent centers Turn 1/2; Centers Cross Run; resulting Centers Trade. The Facing Couples Rule applies to this call.

Note: There are two ways in which Swing and Mix is not simply the call Swing followed by the call Mix. First, reflecting historical usage, Swing and Mix is a single call with three parts while (Any Call) and Mix are two separate calls. Second, from facing couples, Swing and Mix is proper even though Swing is improper.

Switch the Wave

Timing: 6

From a wave: Centers Run, while the ends Cross Run.

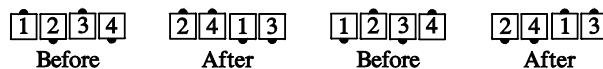

Switch to a Diamond/Hourglass

Switch to a Diamond

Timing: 4

From a wave or line [*At Advanced, this call may be used from waves only*]: Centers Run, while the ends do their part of Diamond Circulate.



Switch to an Hourglass

Timing: 4

From waves or lines [At Advanced, this call may be used from parallel waves only]: Centers Run, while the ends do their part of Hourglass Circulate.

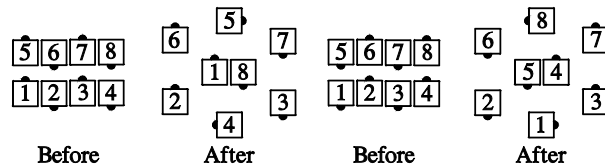

Trade Circulate

Timing: 6

From waves only: Leads Trade, while the trailing center Circulates to the nearest end of the other wave, and the trailing end Circulates to the nearest center of the other wave.

From two-faced lines only: The Leads Partner Trade, while the trailers Diagonal Pass Thru with each other.

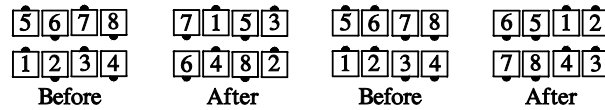

Note: The right-shoulder passing rule applies to this call.

Trail Off

Timing: 6

Starting Formation: Tandem Couples, Box Circulate, or Tandem Dancers in a Z (e.g. from a wave after the Ends Fold)

Lead dancers, turning toward the center of the formation, walk in an approximate wide semicircle to become the far ends of a four-dancer line. Trailing dancers step forward as necessary and walk in a small semicircle around the center point of the starting formation to become the centers of the forming line.

For Tandem Couples each couple must begin their semicircles by crossing paths. The dancer on the right has the right-of-way so the Beau allows the Belle to cross in front (Half Sashay).

For Box Circulate and Right or Left-Hand Z formations, the semicircular path of each leader goes around the other trailer. Each trailer moves forward as necessary to the centerline then Trades with the other trailer (using the same hand as the handedness of the formation).

The four dancers in each of the given starting formations always adjust to end in the same four-dancer line. Each dancer will have turned half (180 degrees) to end facing the opposite direction from which they started. Trail Off, including all necessary adjustments, is danced as one continuous motion that cannot be fractionalized.

Trail Off from Tandem Couples will end in a One-Faced line.

Trail Off from a Box Circulate or from a Right- or Left-Hand Z will end in a like-handed Two-Faced Line.

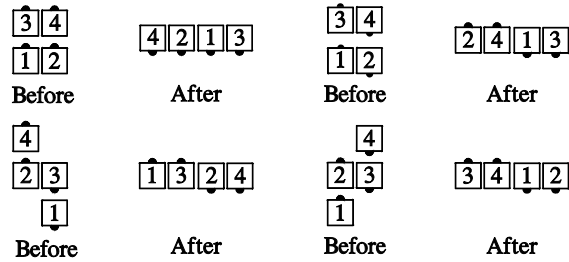

Notes:

Everyone can Roll after a Trail Off.

For the four dancers, the center of the ending formation is the same as the center of the starting formation; however, square breathing adjustments may reposition the whole line.

Trail Off may be thought of as a "Cross" Peel Off. This helps motivate the Belle in front of the Beau dance action.

When the trailers start facing in the same direction, their dance action feels like a Left Shoulder Partner Trade.

Transfer and (Anything)

Timing: 8 (Anything starts on 5)

From columns (or other applicable formation): The #1 and #2 dancers Transfer the Column, omitting the final Extend, ending as an in-facing couple on the outside. The other dancers walk forward to form a box (or other compact formation; this may be less than a full circulate) in the center and do the (Anything) call.

Example: Transfer and Quarter Thru

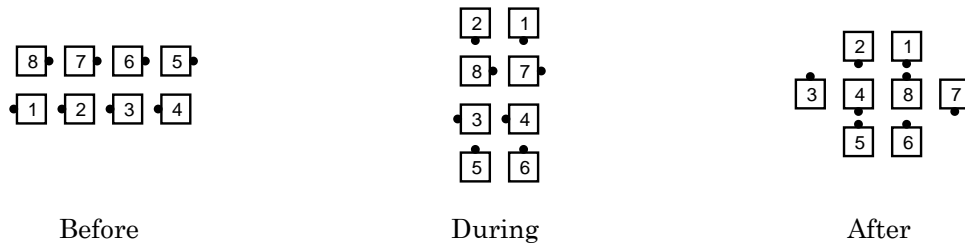

Example: Transfer and Crossfire

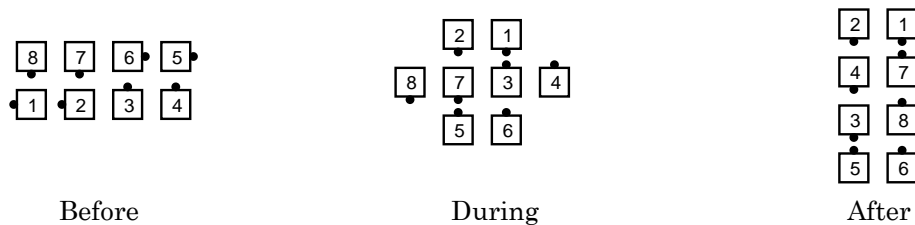

Example: Transfer and Cut the Diamond

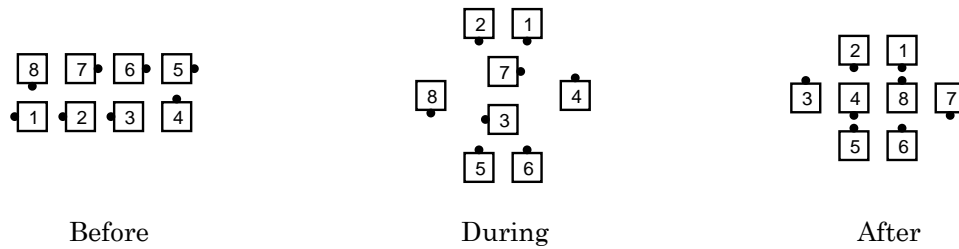

Example: Transfer and Peel and Trail

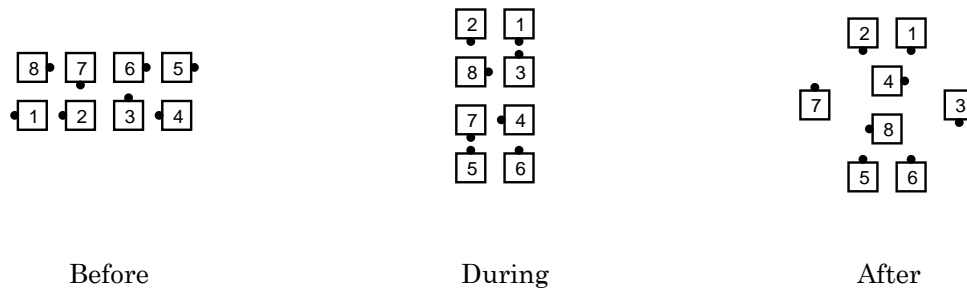

Zig Zag / Zag Zig

Timing: 2

From anywhere there are leads and trailers: Zig means Face Right, and Zag means Face Left. When given in a pair, as in Tag the Line Zig Zag, the call applies to a group of two dancers; each leader does the first (Zig in this case), and each trailer does the second (Zag in this case).

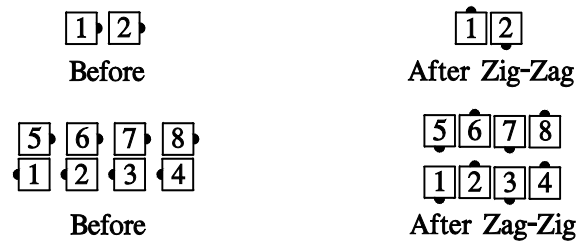

If only one is given, it is directed to the leaders, and the trailers do nothing. In 3/4 Tag the Line, Zig, only the outsides would Face Right:

